

E40 P2 1Relay Output Harness Layout

Last Changed: 17/04/2024

Products that can use this harness

Titan / Venus, Venus2, Venus3
Saturn, Orion, Orion2

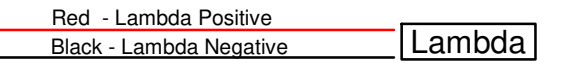
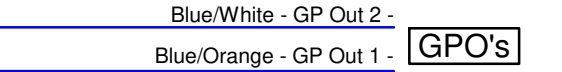
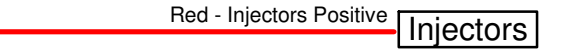
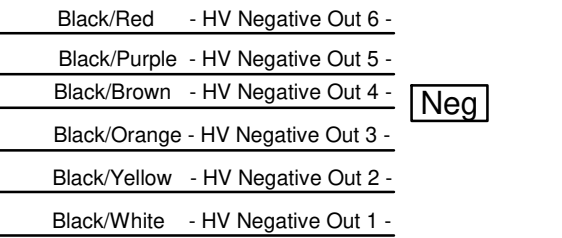
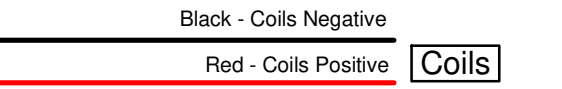
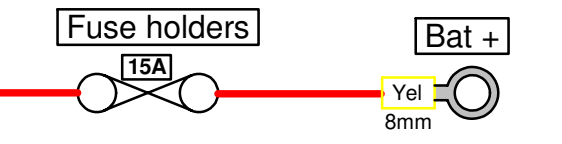
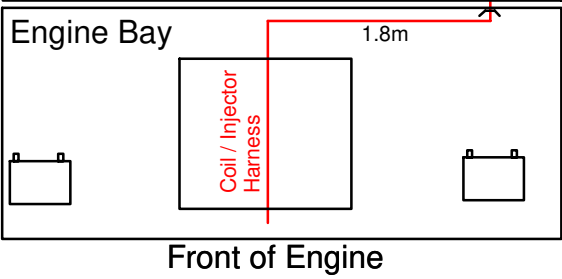
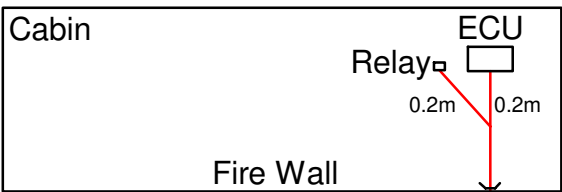
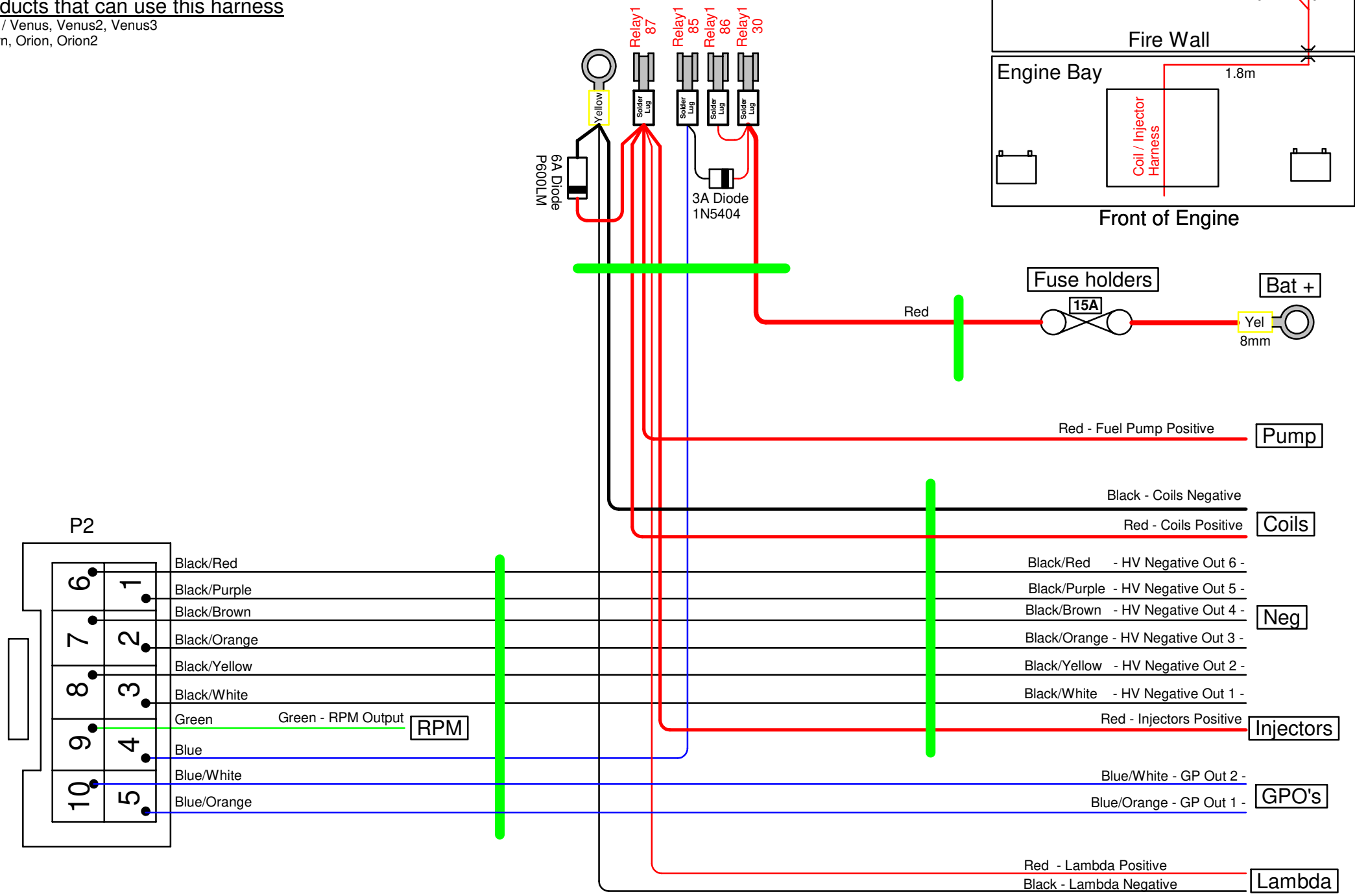

E40 P2 1Relay Output Harness Design

Last Changed: 17/04/2024

Products that can use this harness

Titan / Venus, Venus2, Venus3
Saturn, Orion, Orion2

Note! Use fully insulated Lugs.
Use Relay Holder

